

Hydraulic Quick Coupler



K-Series ISO7241 Series "A" Interchange.

- Interchange Data :**
- Interchangeable to ISO7241 Series 'A'.
 - Parker 6600-series, Aeroquip/Eaton FD 56 (5600).
 - Faster ANV, Hansen HA 15000, Safeway S56-series, DNP-PAV 1 series, Stucchi-BIR series.

- Materials :**
- Machined components are manufactured using solid steel bar stock.
 - Stainless steel balls, retaining rings and springs maximize corrosion resistance and extend service life.
 - Steel componentry is plated using ROHS compliant trivalent chrome.
 - Steel coupler sleeves are hardened to resist deformation and maximise service life
 - Steel nipples are hardened to provide heavy duty performance

Seal Components :

- Nitrile (Buna-N) seals are standard, providing a temperature range of -40°C (- 40°F) to +121°C (250°F).
- Couplers have a PTFE Anti-Extrusion ring.
- Valve seals are crimped in place to maintain integrity during excessive flow conditions and pressurised connection.



COUPLER HANDLING PRECAUTIONS

1. Avoid Connection and disconnecting the coupler when pressure is applied to preclude possible accident.
2. Copuler has been designed to insure complete safety, However avoid subjecting it to shock.
3. Remove foreign matter from the Fluid with a filter before hand. If Foreign matter mixed in the fluid, operation of the internal valve will be adversely effected, causing leakage.
4. Do not weld the coupler directly to Panels and fixtures. This damage the internal seal causing leakage and imperfect flow.
5. When disconnecting the coupler in dusty and sandy locations, always use the specified dust cap.
6. Never tap the valve section with a hammer, etc. to bleed residual pressure.

APPLICATION

For Leakproof Handling of PROCESS LINE, CHEMICALS, GASES, LIQUIDS, HYDRAULICS AND SERVICE LINES LIKE COMPRESSED AIR, STEAM WATER, VACCUM, BRINE, CHILLED WATER, NITROGEN, BREATHING AIR ETC. IN CHEMICAL, REFINARIES, FERTILISER, ATOMIC POWER PLANTS, PHARMACEUTICAL, ENGG., MACHINE TOOL, AUTOMOBILE, PAINT, DYE-STUFF & VARNISH, PETROLEUM, FURNACES, TEXTILE MACHINES, REFRIGERATION INDUSTRIES.

Single Check Valve

TYPE-SC is most popular type coupler used to connect air piping in factories and used to connect air tools with hoses etc. Both socket and plug have hose use and screw use advantages. There is also a variety of other types. The types 20, 30, 40, and Types 400 and 600 are completely interchangeable. With one check valve built into the coupling only whereas plugs do not have any check valves. Can be advantageously used where one side of the flow system needs to be sealed on disconnection.

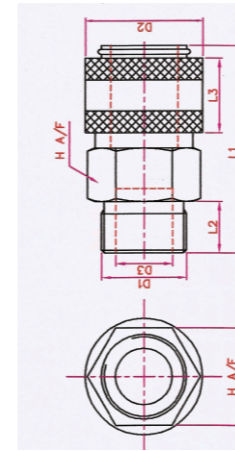

COUPLER BSP(M)

QRC SIZE (D1)	D2	D3	L1	L2	L3	H A/F	
1/8"	17.0	4.5	40.0	8.0	16.0	14 A/F	
1/4"	22.0	6.5	53.0	11.0	19.0	19 A/F	
3/8"	22.0	8.0	53.0	11.0	19.0	19 A/F	
1/2"	32.0	13.0	69.0	14.5	25.0	28 A/F	
3/4"	38.0	17.0	77.0	17.0	28.0	32 A/F	
1"	45.0	22.0	81.0	20.0	29.0	38 A/F	
1 1/4"	48.0	30.0	88.0	22.0	27.0	46 A/F	
1 1/2"	60.0	35.0	104.0	28.0	32.0	55 A/F	
QRC SIZE (D1)	D2	D3	D6	L1	L2	L3	R
2"	75.0	45.0	75.0	116.0	26.0	33.0	72

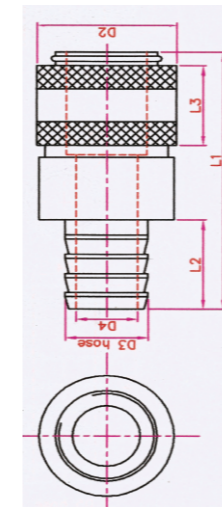

COUPLER (HOSE)

QRC SIZE (D1)	D2	D4	D5	L1	L2	L3	H A/F
1/8"	17.0	6.5	4.0	54.0	20.0	16.0	14 A/F
1/4"	22.0	8.0	5.0	66.0	25.0	19.0	19 A/F
3/8"	22.0	10.0	6.0	67.0	25.0	19.0	19 A/F
1/2"	32.0	13.0	9.0	84.0	30.0	25.0	28 A/F
QRC SIZE (D1)	D2	D3	D4	L1	L2	L3	H1 A/F
3/4"	38.0	20.0	15.0	97.0	36.0	28.0	28 A/F
1"	45.0	27.0	19.0	102.0	40.0	29.0	36 A/F
1 1/4"	48.0	34.0	25.0	115.0	40.0	27.0	45 A/F
1 1/2"	60.0	40.0	28.0	129.0	53.0	32.0	50 A/F
2"	75.0	54.0	43.0	154.0	65.0	33.0	60 A/F

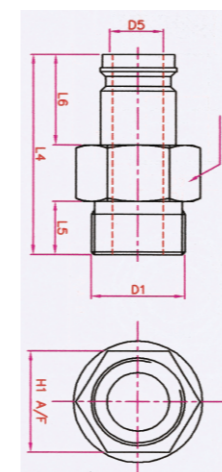

ADAPTOR (BSP(M))

QRC SIZE (D1)	D3	L4	L5	L6	H A/F
1/8"	5.0	28.0	8.0	14.0	14 A/F
1/4"	6.5	33.0	11.0	16.5	19 A/F
3/8"	6.0	35.0	12.0	16.5	19 A/F
1/2"	11.0	43.0	14.5	22.0	28 A/F
QRC SIZE (D1)	D5	L4	L5	L6	H1 A/F
3/4"	15.0	50.0	17.0	25.0	28 A/F
1"	19.0	51.0	17.0	25.0	36 A/F
1 1/4"	25.0	55.0	20.0	25.0	45 A/F
1 1/2"	28.0	71.0	25.0	34.0	50 A/F
2"	42.0	67.0	25.0	30.0	60 A/F

Single Check Valve

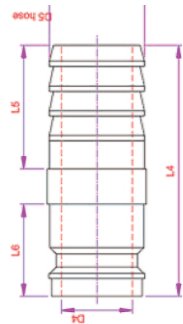

ADAPTOR (HOSE)

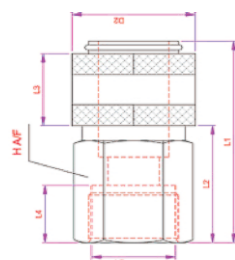
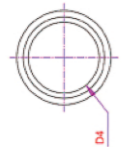

COUPLER

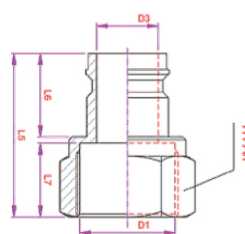
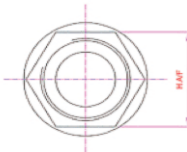

ADAPTOR

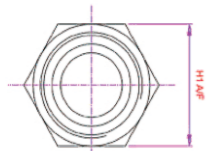

QRC SIZE (D1)	D4	L4	L5	L6	H A/F
1/8"	3.5	41.0	21.5	14.0	14 A/F
1/4"	5.5	46.0	25.0	16.5	19 A/F
3/8"	6.0	46.0	25.0	16.5	19 A/F
1/2"	11.0	58.0	29.0	21.0	28 A/F
3/4"	15.0	67.0	34.0	26.0	32 A/F
1"	20.0	72.0	35.0	26.0	38 A/F
1 1/4"	22.0	85.0	50.0	25.0	46 A/F
1 1/2"	28.0	101.0	53.0	34.0	55 A/F
QRC SIZE (D1)	D4	L4	L5	L6	R
2"	42.0	102.0	65.0	30	72

QRC SIZE (D1)	D2	L1	L2	L3	L4	H A/F
1/4"	17.0	40.0	19.0	16.0	10.0	14 A/F
1/4"	22.0	56.0	34.0	19.0	12.0	19 A/F
3/8"	22.0	54.0	32.0	19.0	12.0	19 A/F
1/2"	32.0	68.0	40.0	25.0	14.0	28 A/F
3/4"	38.0	78.0	45.0	28.0	19.0	32 A/F
1"	45.0	82.0	47.0	29.0	23.0	38 A/F
1 1/4"	48.0	88.0	54.0	27.0	23.0	46 A/F
1 1/2"	60.0	104.0	66.0	32.0	25.0	35 A/F
QRC SIZE (D1)	D2	L1	L2	L3	L4	H1
2"	75.0	115.0	77.0	33	28	65 A/F

QRC SIZE (D1)	D3	L5	L6	L7	H1 A/F	
1/4"	17.0	40.0	19.0	16.0	14 A/F	
1/4"	22.0	56.0	34.0	19.0	16 A/F	
3/8"	22.0	54.0	32.0	19.0	19 A/F	
1/2"	32.0	68.0	40.0	25.0	25 A/F	
3/4"	38.0	78.0	45.0	28.0	32 A/F	
1"	45.0	82.0	47.0	29.0	38 A/F	
1 1/4"	48.0	88.0	54.0	27.0	46 A/F	
1 1/2"	60.0	104.0	66.0	32.0	55 A/F	
QRC SIZE (D1)	D4	L5	L6	L7	L4	H1
2"	75.0	115.0	77.0	33	28	65 A/F

Quick Connect Couplers



Model 20 PF

Model 20 PF offered come in heavy duty construction finish and provide for quick coupling support. The product provides for proven and positive connection using ball-locking mechanism and find suitability for use with pneumatic systems. Some of its features include heavy duty construction design; accepting 1/4 NITTO type plugs; capability to handle working pressures of less than 145 Psi; working temperature range of -20 to 70 degree Celsius and others.

Features:

1. Accepts 1/4 NITTO type plugs
2. Heavy-duty,high-quality design
3. Deep knurled socket sleeve for positive gripping
3. Proven and positive connection using ball-locking mechanism

Specifications:

1. Used for pneumatic systems.
2. Working pressure: Less than 145 Psi; Max pressure: 150 Psi.
3. Material: Brass and steel are both available.
4. Temperature range: -20~70 Celsius degree.
5. Air flow: 35 SCFM at 100 PSIG inlet with 10 PSIG pressure.

Model 20 PH offered come in heavy duty construction finish and provide for quick coupling support. The product provides for proven and positive connection using ball-locking mechanism and find suitability for use with pneumatic systems. Some of its features include heavy duty construction design; accepting 1/4 NITTO type plugs; capability to handle working pressures of less than 145 Psi; working temperature range of -20 to 70 degree Celsius and others.



Model 20 PH

Features:

1. Accepts 1/4 NITTO type plugs
2. Heavy-duty,high-quality design
3. Deep knurled socket sleeve for positive gripping
4. Proven and positive connection using ball-locking mechanism

Specifications:

1. Used for pneumatic systems.
2. Working pressure: Less than 145 Psi; Max pressure: 150 Psi.
3. Material: Brass and steel are both available.
4. Temperature range: -20~70 Celsius degree.
5. Air flow: 35 SCFM at 100 PSIG inlet with 10 PSIG pressure.

Quick Connect Couplers



Model 20 SH offered comes designed and finished to accept 1/4 NITTO type plugs and come in heavy-duty construction finish for lasting service performance. Further, these come in high-quality design standards and feature presence of deep knurled socket sleeve for delivering positive gripping support. Some of its features suitable for use in pneumatic systems maximum pressure of 150 Psi; available in stainless steel/brass material finish; working temperature range of -20 to 70 degree Celsius among others.

Model 20 SH

Features:
1. Accepts 1/4 NITTO type plugs
2. Heavy-duty,high-quality design
3. Deep knurled socket sleeve for positive gripping
3. Proven and positive connection using ball-locking mechanism

Specifications:
1. Used for pneumatic systems.
2. Working pressure: Less than 145 Psi; Max pressure: 150 Psi.
3. Material: Brass and steel are both available.
4. Temperature range: -20~70 Celsius degree.
5. Air flow: 35 SCFM at 100 PSIG inlet with 10 PSIG pressure.

Model 20 PM offered come in heavy duty construction finish and provide for quick coupling support. The product provides for proven and positive connection using ball-locking mechanism and find suitability for use with pneumatic systems. Some of its features include heavy duty construction design; accepting 1/4 NITTO type plugs; capability to handle working pressures of less than 145 Psi; working temperature range of -20 to 70 degree Celsius and others.



Model 20 PM

Features:
1. Accepts 1/4 NITTO type plugs
2. Heavy-duty,high-quality design
3. Deep knurled socket sleeve for positive gripping
4. Proven and positive connection using ball-locking mechanism

Specifications:
1. Used for pneumatic systems.
2. Working pressure: Less than 145 Psi; Max pressure: 150 Psi.
3. Material: Brass and steel are both available.
4. Temperature range: -20~70 Celsius degree.
5. Air flow: 35 SCFM at 100 PSIG inlet with 10 PSIG pressure.

Double Check Valve

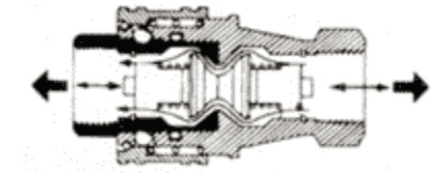
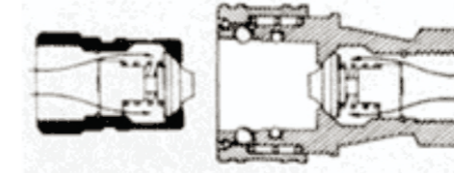

The valve of the socket and plug is pushed against the valve seat and closed automatically. There is no leakage of the fluid.

The valves of the socket and plug are pushed against each other, the interior of the coupling is opened, and the outside of the plug and there is no leakage to the outside.

Features :

- Since both the plug and socket have a value, there is no leakage of gas, oil, etc. from either the socket or plug ends when disconnected.
- Since they are manufactured by an especially high precision machining process, air tightness is a high 10⁻⁴ mmHg / sec.
- The hose does not twist.
- Designed for use in a wide range of applications



COUPLER (BSP(F))



ADAPTOR (BSP(F))

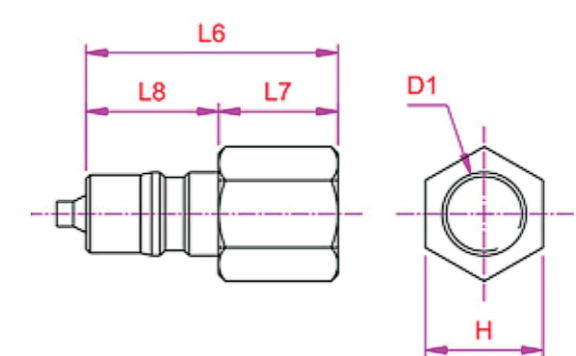
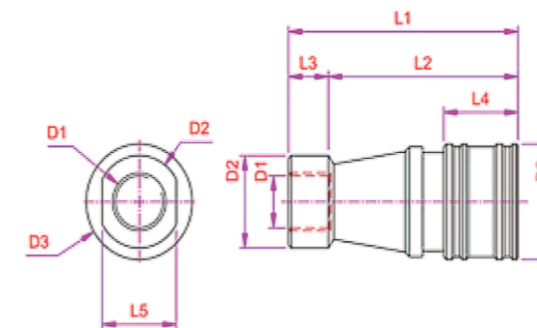

QRC SIZE (D1)	D2	D3	L1	L2	L3	L4	L5	L6	L7	L8	H
1/8"	16.0	20.0	43.0	35.8	7.5	14.0	14.0	30.0	14.2	15.8	14.0 A/F
1/4"	22.0	28.0	58.0	48.0	11.0	18.0	19.0	36.0	13.0	23.0	19.0 A/F
3/8"	26.0	35.0	65.0	52.0	14.0	20.0	22.0	40.0	14.0	26.0	22.0 A/F
1/2"	32.0	42.0	71.0	56.0	15.0	24.0	28.0	45.0	19.0	26.0	28.0 A/F
3/4"	36.0	45.0	76.0	58.0	18.0	26.0	32.0	49.0	20.0	29.0	32.0 A/F
1 1/4"	58.0	70.0	95.0	72.0	23.0	29.0	52.0	59.0	24.0	35.0	51.0 A/F
1 1/2"	64.0	75.0	95.0	72.0	23.0	29.0	61.0	59.0	24.0	35.0	55.0 A/F

QRC SIZE (D1)	D2	D3	D4	L1	L2	L3	L4	L5	L6	L7	L8	H
1"	45.0	55.0	45.0	85.0	63.0	22.0	27.0	41.0	56.0	26.0	30.0	41.0
2"	75.0	85.0	70.0	113.0	84.0	30.0	33.0	69.0	72.0	30.0	42.0	66.0

QRC SIZE (D1)	D2	D3	D4	L1	L2	L3	L4	L5	L6	L7	L8	H
2 1/2"	90.0	108.0	90.0	125.0	100.0	25.0	37.0	84.0	75.0	22.0	53.0	84.0
3"	110.0	130.0	110.0	130.0	105.0	25.0	37.0	104.0	75.0	22.0	53.0	84.0

Straight Through Valve

This is a double path open type coupler which does not have a valve mechanism at either the socket nor the plug. It is used in piping systems in which blocking of the fluid when disconnected is unnecessary and closure of lines is achieved by back up valves. Permit full flow capability due to their smooth and accurately finished bores.

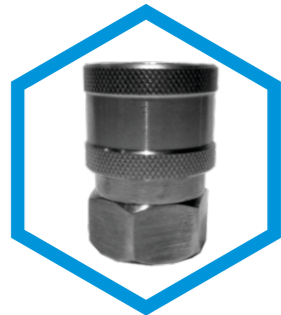
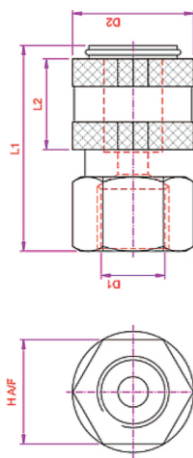

COUPLER (BSP(F))

QRC SIZE (D1)	D2	L1	L2	R
1/8"	17.0	29.0	16.0	16 A / F
1/4"	22.0	35.0	16.0	19 A / F
3/8"	25.0	42.0	21.0	22 A / F
1/2"	32.0	46.0	25.0	28 A / F
3/4"	35.0	48.0	26.0	32 A / F
1"	42.0	50.0	26.0	38 A / F
1 1/4"	55.0	66.0	29.0	50 A / F
1 1/2"	60.0	61.0	31.0	55 A / F
2"	84.0	74.0	34.0	75 A / F

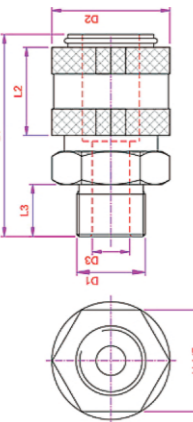

COUPLER (BSP(M))

QRC SIZE (D1)	D2	D3	L1	L2	L3	R
1/8"	19.0	4.5	35.0	15.0	10.0	16 A / F
1/4"	22.0	6.5	38.0	16.0	11.0	19 A / F
3/8"	25.0	9.0	48.0	21.0	12.0	22 A / F
1/2"	32.0	12.0	54.0	25.0	14.0	28 A / F
3/4"	35.0	17.0	58.0	26.0	15.0	32 A / F
1"	42.0	24.0	60.0	26.0	20.0	38 A / F
1 1/4"	55.0	30.0	57.0	29.0	20.0	50 A / F
1 1/2"	60.0	35.0	57.0	31.0	25.0	55 A / F
2"	84.0	45.0	80.0	34.0	25.0	75 A / F

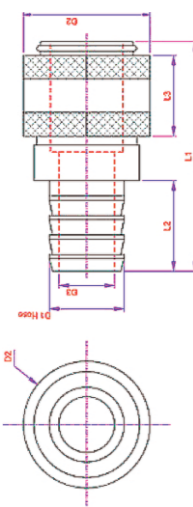

COUPLER (HOSE)

QRC SIZE (D1)	D2	D3	L1	L2	L3
1/8"	17.0	4.0	45.0	20.0	16.0
1/4"	22.0	5.0	52.0	25.0	19.0
3/8"	22.0	6.0	60.0	25.0	19.0
1/2"	32.0	9.0	70.0	30.0	25.0
3/4"	35.0	15.0	79.0	36.0	28.0
1"	42.0	19.0	80.0	40.0	29.0
1 1/4"	55.0	25.0	82.0	45.0	27.0
1 1/2"	60.0	28.0	96.0	45.0	32.0
2"	75.0	43.0	105.0	50.0	33.0

Quick Connect Couplers



Model 20 SM

Model 20 SM offered feature precision construction finish and find suitability for accepting of 1/4 NITTO type plugs. Coming in heavy-duty construction finish and quality design standards, the product also comes with deep knurled socket sleeve for providing positive gripping support. Some of its features include provide for positive connection using superior ball-locking mechanism; allows for quick coupling support; suitable for use in pneumatic systems; capability to handle maximum pressure of 150 Psi.

Features:

1. Accepts 1/4 NITTO type plugs
2. Heavy-duty,high-quality design
3. Deep knurled socket sleeve for positive gripping

Specifications:

1. Used for pneumatic systems.
2. Working pressure: Less than 145 Psi; Max pressure: 150 Psi.
3. Material: Brass and steel are both available.
4. Temperature range: -20~70 Celsius degree.
5. Air flow: 35 SCFM at 100 PSIG inlet with 10 PSIG pressure.

Model 20 SF offered can be made available by us in durable and sturdy finish support and find suitability for use in pneumatic systems. The product is suitable for use in working pressure of less than 145 Psi and can be developed in both brass and steel metal finish. Some of its features include working temperature range of -20 to 70 degree Celsius; air flow rate of 35 SCFM at 100 PSIG inlet with 10 PSIG pressure; heavy-duty construction design; quick coupling support through ball-locking mechanism among others.



Model 20 SF

Features:

1. Accepts 1/4 NITTO type plugs
2. Heavy-duty,high-quality design
3. Deep knurled socket sleeve for positive gripping
4. Proven and positive connection using ball-locking mechanism

Specifications:

1. Used for pneumatic systems.
2. Working pressure: Less than 145 Psi; Max pressure: 150 Psi.
3. Material: Brass and steel are both available.
4. Temperature range: -20~70 Celsius degree.
5. Air flow: 35 SCFM at 100 PSIG inlet with 10 PSIG pressure.

Jeeffy Type Coupling



Plug Male

Plug Male offered come in precision constructed finish and is made available under range mold couplings. Here, our expertise lies in offering these in steel (nickel plated), bras and stainless steel metal finish options. Some of its features include available in work pressure options of 300 PSI; available size options of 1/8" BSP, 1/4" BSP, 3/8" BSP, 1/2" BSP, 1/2" BSP, 3/4" BSP, 1" BSP; choice of availability in OEM specifications as demanded by the customers.

Hose Socket offered come in precision designed & constructed finish and are made available under head mold couplings. These sockets allow achieving symmetrical quick connection without male/female threads, thus making them suitable for making connection to fire hoses. Further, the use of superior grade alloy finish also makes these provide for longer service life, corrosion proof usage as well as maintenance-free performance. Some of its features include allows usage as symmetrical quick connection socket; socket has no female and male part and allows for easy usage while connecting to hose ends and others.



Hose Socket



Extra Long Plug

Extra Long Plug offered comes in precision designed and constructed finish and provides for optimum functional support in given application demands. Offered under range mold couplings, these are made available in standard sealing material of Nitrile (-20° C to +75° C) as well as in options of Viton (-20° C to +170° C). Some of it features include available in different metal choices like nickel plated steel, stainless steel, brass and others; suitable for handling work pressures of 300 PSI; option of OEM construction and others.

Straight Through Valve

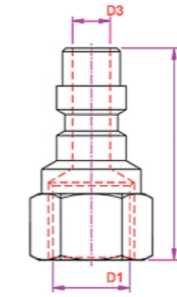

ADAPTOR (BSP(F))

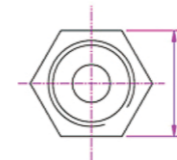

QRC SIZE (D1)	D3	L3	H1 A / F
1/8"	5.0	30.0	14 A / F
1/4"	6.5	32.0	16 A / F
3/8"	7.0	38.0	22 A / F
1/2"	11.0	45.0	25 A / F
3/4"	15.0	50.0	32 A / F
1"	19.0	50.0	38 A / F
1 1/4"	24.0	66.0	45 A / F
1 1/2"	31.0	61.0	55 A / F
2"	48.0	74.0	65 A / F

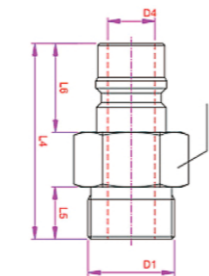

ADAPTOR (BSP(M))

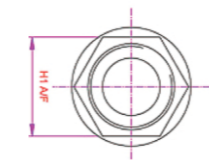

QRC SIZE (D1)	D4	L4	L5	L6	H1 A / F
1/8"	5.0	31.0	10.0	15.5	12.5 A / F
1/4"	6.5	35.0	11.0	16.5	14 A / F
3/8"	7.0	37.0	12.0	20.0	17 A / F
1/2"	12.0	47.0	14.0	25.0	22 A / F
3/4"	15.0	50.0	15.0	25.0	28 A / F
1"	19.0	55.0	20.0	25.0	36 A / F
1 1/4"	24.0	68.0	20.0	25.0	45 A / F
1 1/2"	31.0	69.0	25.0	34.0	55 A / F
2"	48.0	82.0	25.0	30.0	65 A / F

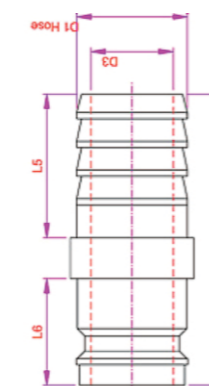

ADAPTOR (HOSE)

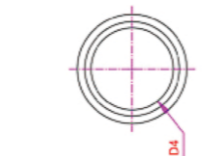

QRC SIZE (D1)	D3	L4	L5	L6
1/8"	4.0	40.0	20.0	14.0
1/4"	5.0	49.0	25.0	16.5
3/8"	6.0	53.0	25.0	16.5
1/2"	9.0	62.0	30.0	22.0
3/4"	15.0	66.0	30.0	25.0
1"	19.0	73.0	40.0	25.0
1 1/4"	25.0	90.0	45.0	25.0
1 1/2"	28.0	89.0	45.0	34.0
2"	43.0	103.0	50.0	30.0

Cam lock Coupling

PERFECT - TITE couplings enable pipe and hose connections to be made without the use of hands tools; thus eliminating the difficulty in making threaded connections or a flanged connection. Almost instantly connections can be made to an outlet, a faucet, a valve, a tank or coupling lengths of hose. No pipe fitting skills, wrenches or tools are required. A connection is made by simply pushing the handles down to the sides of the coupler.

DESIGN AND CONSTRUCTION



- SUPERIOR quality body – precision machined surfaces
- Meets or exceeds Military standards
- Highest quality standards employed
- Uniform wall thickness assessors no coupler bodies
- Large diameter cam ears for longer service life
- Extra high strength handles for assurance in connections
- Recess retains gasket in coupler
- Stainless Steel cam pins for long wear and ease of replacement

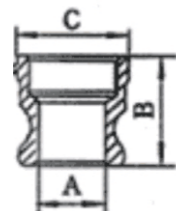

TYPE-A

SIZE	1/2"	3/4"	1"	1 1/4"	1 1/2"	2"	2 1/2"	3"	4"	5"	6"
A	21	21	24	28.5	36	45	56.5	73	98	122	148
B	38	38	48	56	60	46	87	73	78	95	86
C	32	32	40	48	56	67	83	96	127	154	190

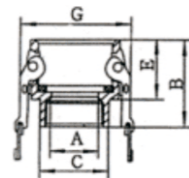

TYPE-D

SIZE	1/2"	3/4"	1"	1 1/4"	1 1/2"	2"	2 1/2"	3"	4"	5"	6"
A	16	19	26	30	39	50	58	72	98	122	145
B	52	52	62	68	71	78	85	91	96	102	118
C	32	32	40	48	56	67	83	96	127	154	190
E	32	32	40	48	49	54	69	60	62	62	72
G	53	53	60	78	85	96	110	127	156	185	220

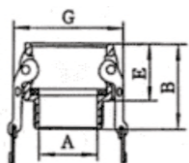
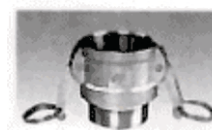

TYPE-B

SIZE	1/2"	3/4"	1"	1 1/4"	1 1/2"	2"	2 1/2"	3"	4"	5"	6"
A	14	14	24	28	35	51	58	72	98	122	145
B	52	52	64	72	73	80	90	94	101	102	118
E	32	32	40	48	49	54	59	60	62	32	72
G	53	53	60	78	85	96	110	127	156	185	220

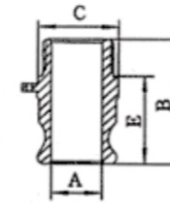

TYPE-F

SIZE	1/2"	3/4"	1"	1 1/4"	1 1/2"	2"	2 1/2"	3"	4"	5"	6"
A	21	21	24	28.5	36	45	56.5	73	98	122	148
B	56	56	72	80	84	88	100	106	114	121	130
C	32	32	40	48	56	67	83	96	127	154	190
E	39	39	48	48	56	61	62	69	74	79	82

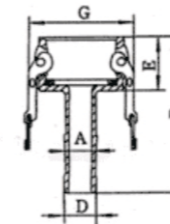
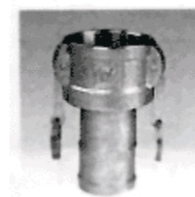

TYPE-C

SIZE	1/2"	3/4"	1"	1 1/4"	1 1/2"	2"	2 1/2"	3"	4"	5"	6"
A	16	19	26	30	39	50	58	72	98	122	145
B	52	52	62	68	71	78	85	91	96	102	118
D	32	32	40	48	56	67	83	96	127	154	190
E	32	32	40	48	49	54	59	60	62	62	72
G	53	53	60	78	85	96	110	127	156	185	220

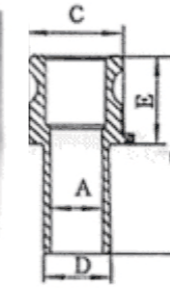

TYPE-E

SIZE	1/2"	3/4"	1"	1 1/4"	1 1/2"	2"	2 1/2"	3"	4"	5"	6"
A	14	19	24	28	35	48	58	72	98	122	145
B	98	98	110	121	125	140	158	170	182	196	220
D	20	20	26	33	39	52	65	77	103	130	155
E	40	40	46	53	56	61	65	66	70	72	79
C	34	34	38	48	56	66	80	102	132	154	184

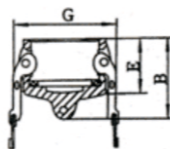

TYPE-Dus Cap

SIZE	1/2"	3/4"	1"	1 1/4"	1 1/2"	2"	2 1/2"	3"	4"	5"	6"
B	45	45	54	65	69	80	84	85	94	94	112
E	32	32	40	48	49	54	59	60	62	62	72
G	53	53	60	78	85	96	110	127	156	185	220

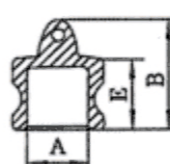

TYPE-Dus Plug

SIZE	1/2"	3/4"	1"	1 1/4"	1 1/2"	2"	2 1/2"	3"	4"	5"	6"
A	21	21	24	28.5	36	45	56.5	73	98	122	148
B	37	37	44	55	64	68	70	80	80	80	98
E	24	24	30	38	41	43	45	52	48	48	58